

# MaxMotion

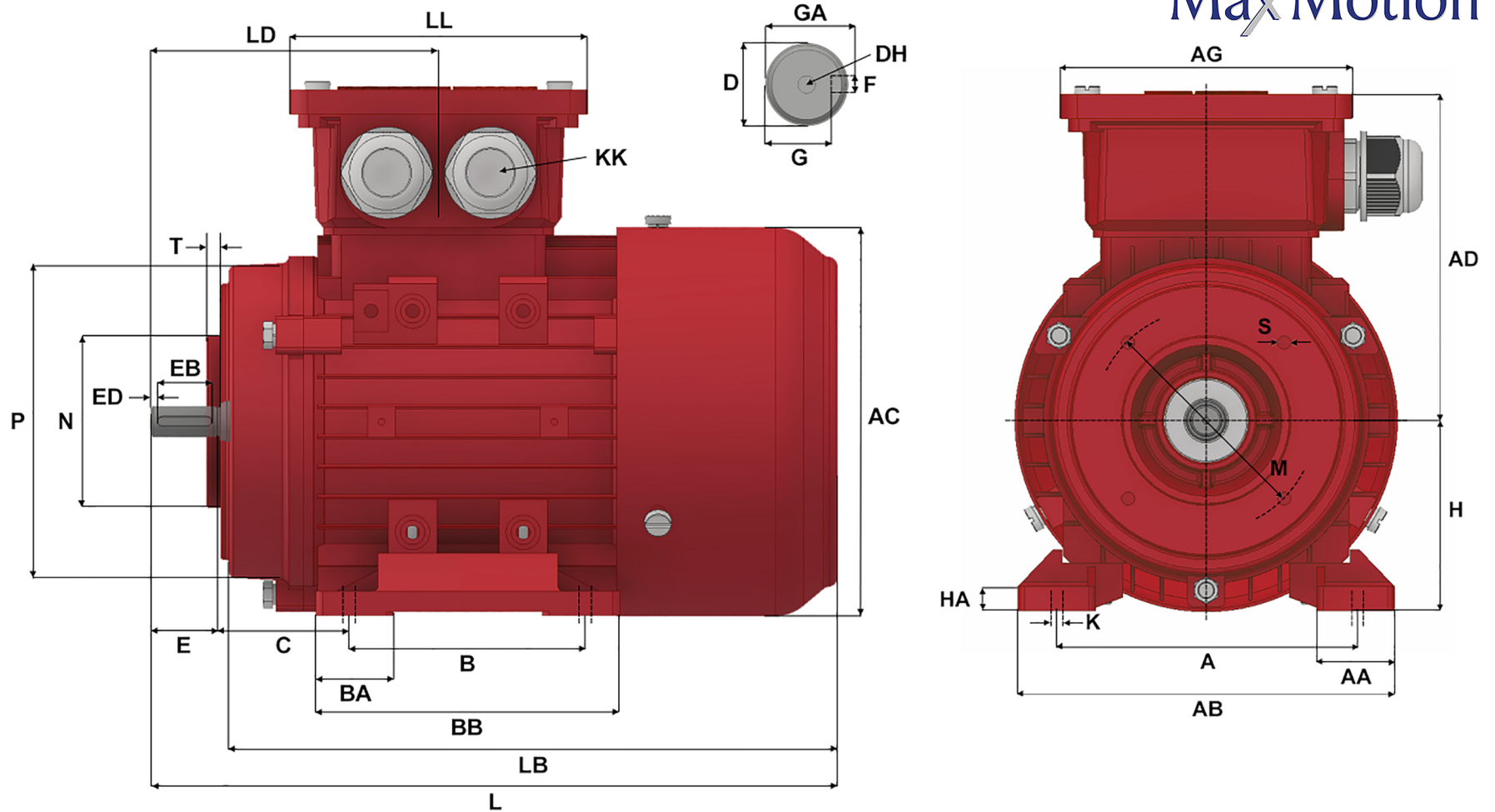

Version: 1JLEM		Revised: 09-11-2019		HP	RPM	FRAME	ENCLOSURE	IJA633-2-B34A								
Customer is responsible in determining that Max Motion product will fit/perform suitably in the intended application								0.5	3285	63	TEFC					
A	B	C	D	E	F	G	H	K	L	M	N	P				
100	80	40	11	23	4	8.5	63	7 X 9.5	217	75	60	90				
S	T	AA	AB	AC	AD	AG	BA	BB	DH	EB	ED	GA				
M5	2.5	24	123	120	103	101	23.58	100	M4 X 12	16	3.5	12.5				
HA	KK (1)	KK (2)	KK (3)	LB	LD	LL										
7	M20 X 1.5	1/2" NPT	-	194	95.5	101										